

SPECIFICATIONS

Dimensions: 3 1/4"W x 1 7/8"H x 1"D
(83 x 47 x 25mm)

Weight: 6oz (.2kg)

OTHER RUSSOUND IR COMPONENTS

845.1 Single Infrared Emitter

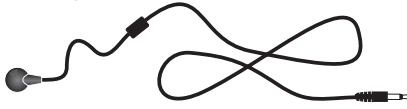

1584.1 Dual Infrared Emitter

IRB-1 In-Wall
Connecting Block



IRB-5 In-Wall
Connecting Block



IRB-6 In-Wall
Connecting Block

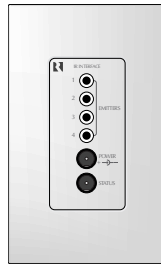

858 In-Wall
IR Receiver



854 Mini Tabletop
IR Receiver



LIMITED WARRANTY

The Russound 857 IR Receiver is fully guaranteed for two (2) years from the date of purchase against all defects in materials and workmanship. For this warranty to apply, the unit must be installed and used according to its written instructions. During this period, Russound will replace any defective parts and correct any defect in workmanship without charge for either parts or labor. Accidental damage and shipping damage are not considered defects under the terms of this warranty. Russound assumes no responsibility for defects resulting from abuse or servicing performed by an agency or person not specifically authorized in writing by Russound. If service is necessary, it must be performed by Russound. Damage to or destruction of components due to excessive power voids the warranty. In these cases, the repair will be made at the owner's expense. To return for repairs, the unit must be shipped to Russound at the owner's expense, along with a note explaining the nature of the service required. Be sure to pack in a corrugated container with at least 3 inches of resilient material to protect the unit from damage in transit.

Before returning a unit for repair, call Russound at (603) 659-5170 for a Return Authorization number. Write the RA number on the shipping label and ship to: Russound, ATTN: Service, 5 Forbes Road, Newmarket NH 03857

Russound sells product only through authorized Dealers and Distributors to ensure that customers obtain proper support and service. Any Russound product purchased from an unauthorized dealer or other source, including retailers, mail order sellers and online sellers will not be honored or serviced under existing Russound warranty policy. Any sale of products by an unauthorized source or other manner not authorized by Russound shall void the warranty on the applicable product.

Russound[®]
A/V DISTRIBUTION & CONTROL SYSTEMS

5 Forbes Rd. Newmarket, NH 03857, USA
☎ 603.659.5170 • Fax 603.659.5388
e-mail: tech@russound.com

*the right
connection*

Come visit us at:

www.russound.com

Russound[®]
A/V DISTRIBUTION & CONTROL SYSTEMS

Infrared Connecting Block 857 *SaphIR* Instruction Manual

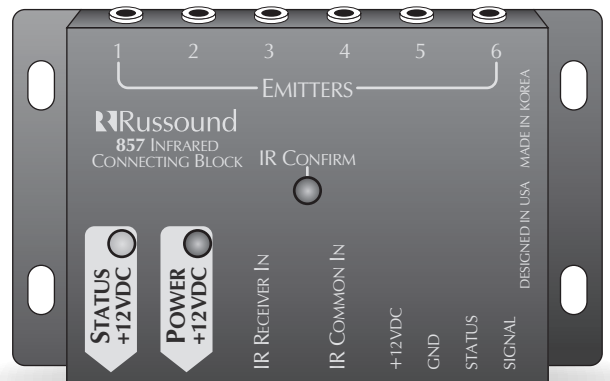

PRODUCT OVERVIEW

The 857 Connecting block connects IR receivers, power supply and emitters, together to interface the IR system to the audio / video components.

KEY FEATURES

- 1) Six emitter output connections.
- 2) Convenient IR confirmation LED.
- 3) Status power receptacle with LED indicator.
- 4) Power receptacle with LED indicator.
- 5) Three conductor 1/8" receptacle for interfacing with many brands of freestanding IR receivers.
- 6) Two conductor 1/8" receptacle for common IR input.
- 7) Large detachable IR receiver connection.
- 8) Compact size for mounting near audio equipment.

857 CONNECTIONS

Power: Connect a 12 VDC 200 mA to 1A power supply to the power jack. 2.1mm + Tip – sleeve. The red LED will be illuminated when powered. This will power all of the IR components connected to the system. Depending on the type of components and the number of components will determine how much current the power supply will need to provide.

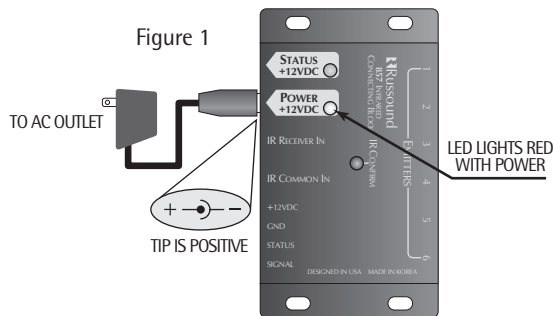

Status Power: 12VDC 200mA 2.1mm + tip –sleeve. Connecting a power supply to this connection will power the status connection. The green LED will be illuminated when powered. This can be from a 12 volt trigger output or from a wall type power supply plugged into a switched outlet of a stereo receiver. If you are using products like the 858 that have a status indicator, simply plug a 12 VDC power supply into the switched outlet and when the receiver is turned on the status LED will be illuminated.

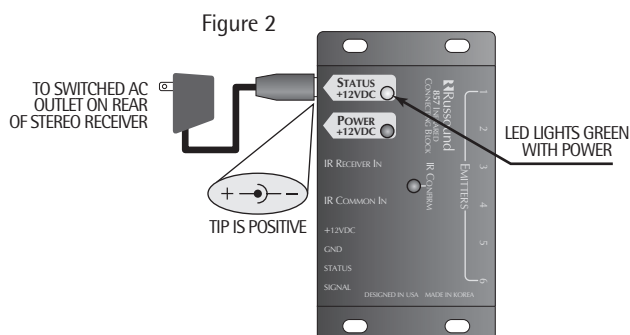

IR Receiver In: This is a three terminal 1/8" plug that is common to many of the free standing IR receivers. This will connect the power, ground and signal. Signal is Tip, ground is the ring and power is the sleeve.

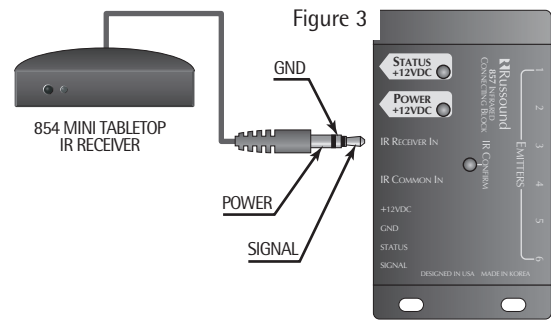

IR Common In: This is a two terminal 1/8" plug. Signal is tip, ground sleeve. This can be connected the IR output of a stereo receiver or the common IR output of an audio distribution system.

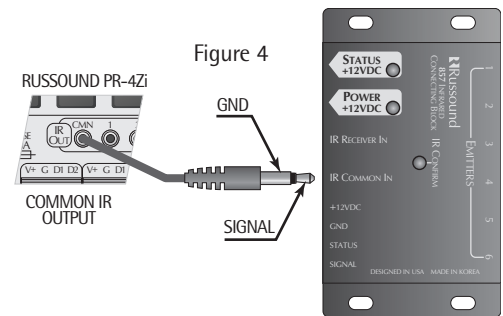

System Connection: Connect the IR system to the detachable connector labeled +12VDC, GND, STATUS and SIGNAL.

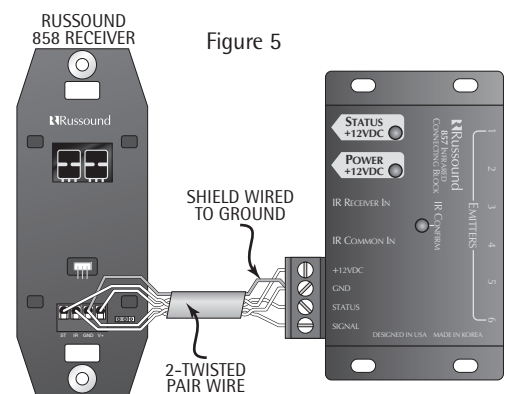

Emitter Outputs: Connect up to 6 emitters to the emitter jacks labeled 1-6. Place the emitters on the source equipment.

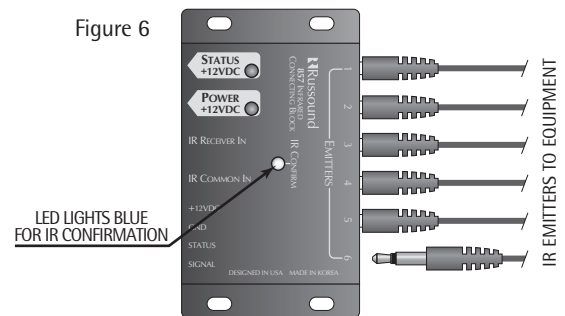

IR Confirm: When an IR signal is received the IR confirmation blue LED will flash.

Mounting: Mount the 857 near the source equipment that the emitters are attached to.